

13 12 11 10 9 8 7 6 5 4 3 2 1

J I H G F E D C B A

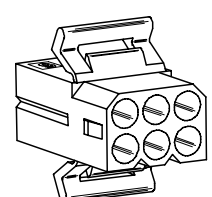

RECEPTACLE

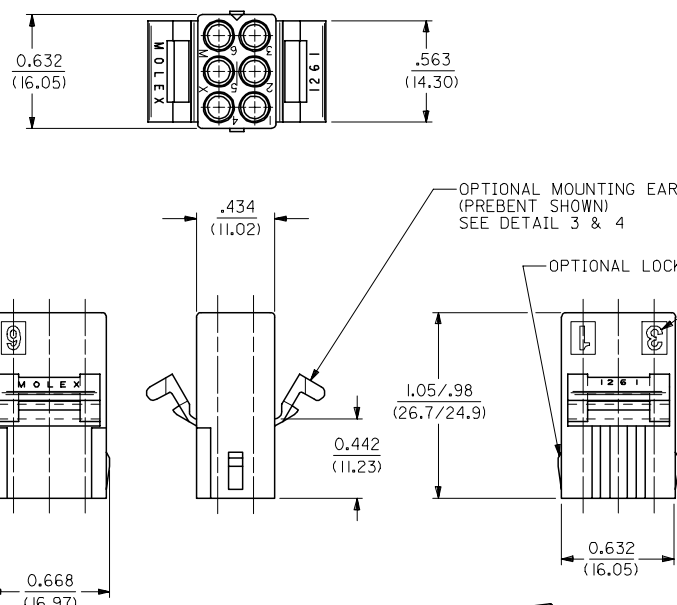
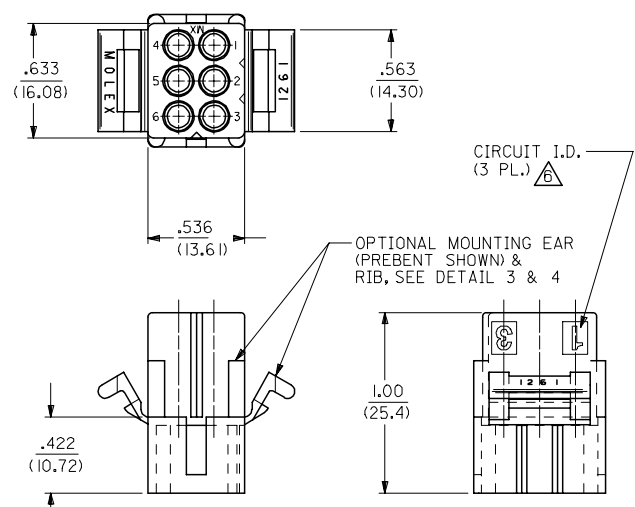
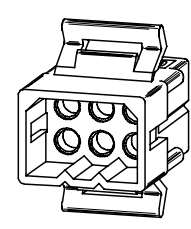
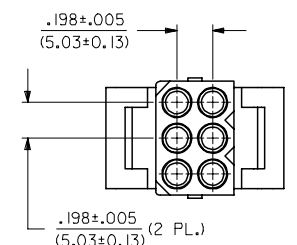
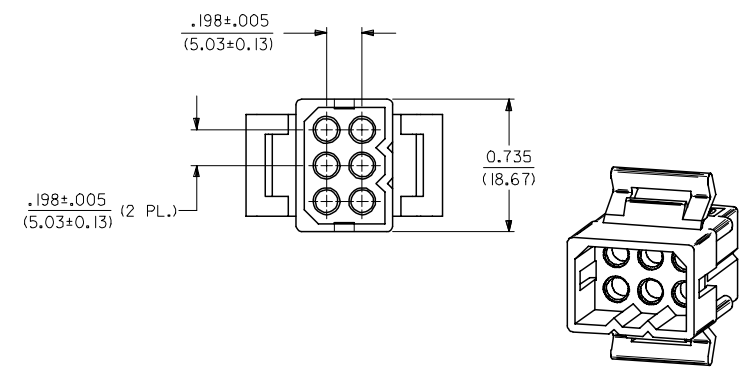

PLUG

REVISED NOTES EC NO: UCP2006-2424 DRAWN/PRI/DOR 2006/06/08 CHKD: AEL/HAG 2006/06/08 APPR: FSM/TH 2006/06/09	QUALITY SYMBOLS 	GENERAL TOLERANCES (UNLESS SPECIFIED)		DIMENSION STYLE IN/MM		SCALE 2:1	DESIGN UNITS INCH	THIRD ANGLE PROJECTION	
		mm	INCH	DRAWN BY	DATE	TITLE			
		4 PLACES ± .005	± .005	GWC	11/6/89	.093/(2.36) HOUSING, PLUG AND RECEPTACLE, 6 CKT., .198/(5.03)CTRS.			
		3 PLACES ± .007	± .007	CHECKED BY	DATE	MOLEX INCORPORATED			
2 PLACES ± 0.18	± 0.10	RW	11/6/89	MATERIAL NO. DOCUMENT NO. SHEET NO.					
1 PLACE ± 0.25	± .005	APPROVED BY	DATE	SD-1261-*					
ANGULAR ± 2 °		GWF	11/6/89	SEE CHART					
DRAFT WHERE APPLICABLE MUST REMAIN WITHIN DIMENSIONS		SIZE		THIS DRAWING CONTAINS INFORMATION THAT IS PROPRIETARY TO MOLEX INCORPORATED AND SHOULD NOT BE USED WITHOUT WRITTEN PERMISSION					

12 11 10 9 8 7 6 5 4 3 2 1

13 12 11 10 9 8 7 6 5 4 3 2 1

PLUG

PART NO.	ENG. NO.
03-09-2061	I261-P
23-09-2061	I261-P-100
03-09-2062	I261-P1
23-09-2062	I261-P1-100
03-09-7061	I261-PBK
03-09-7062	I261-P1BK
27-09-2093	I261-P1-200
50-29-0099	I261-P1-300

RECEPTACLE

PART NO.	ENG. NO.
03-09-1061	I261-R
23-09-1061	I261-R-100
03-09-1062	I261-R1
23-09-1062	I261-R1-100
03-09-1063	I261-R2
23-09-1063	I261-R2-100
03-09-1064	I261-R3
27-09-1063	I261-R2-200
03-09-6064	I261-R3BK
03-09-6063	I261-R2BK
03-09-6062	I261-R1BK
03-09-6061	I261-RBK
50-29-1500	I261-R3-300

LEGEND: PLUG

I261-P***-***

P = PLUG

BLANK = PLUG WITH PREBENT MOUNTING EARS

I = PLUG WITHOUT MOUNTING EARS

COLOR: BLANK=NATURAL COLOR

AM=AMBER BK=BLACK BU=BLUE
 BN=BROWN GY=GRAY GN=GREEN
 OR=ORANGE RD=RED YW=YELLOW

MATERIAL: BLANK = NYLON 6/6, U.L. 94V-2
 100 = POLYPROPYLENE, U.L. 94V-0
 200 = NYLON 6/6, U.L. 94V-0, RED
 300 = NYLON 6/6, U.L. 94V-2, BLACK
 UV RESISTANT

LEGEND: RECEPTACLE

I261-R***-***

R = RECEPTACLE

BLANK = WITH STD. MOUNTING EARS, WITH LOCK RAMPS

1 = WITH STD. MOUNTING EARS, WITHOUT LOCK RAMPS

2 = WITHOUT MOUNTING EARS, WITHOUT LOCK RAMPS

3 = WITHOUT MOUNTING EARS, WITH LOCK RAMPS

4 = WITH PREBENT MOUNTING EARS, WITH LOCK RAMPS

5 = WITH PREBENT MOUNTING EARS, WITHOUT LOCK RAMPS

COLOR: BLANK=NATURAL COLOR

AM=AMBER BK=BLACK BU=BLUE
 BN=BROWN GY=GRAY GN=GREEN
 OR=ORANGE RD=RED YW=YELLOW

MATERIAL: BLANK = NYLON 6/6, U.L. 94V-2
 100 = POLYPROPYLENE, U.L. 94V-0
 200 = NYLON 6/6, U.L. 94V-0, RED
 300 = NYLON 6/6, U.L. 94V-2, BLACK
 UV RESISTANT

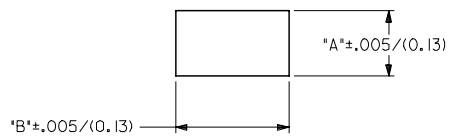
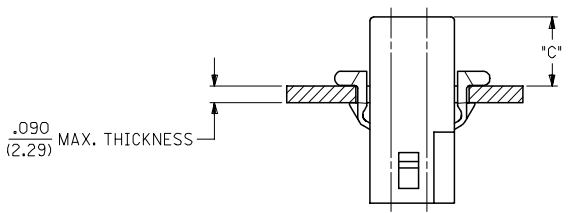

MOUNTING HOLE CUTOUT

HOUSING	DIM. 'A'	DIM. 'B'	DIM. 'C' (STD. EAR)	DIM. 'C' (PREBENT)
PLUG	.750/(19.05)	.695/(17.65)	.39/(9.9)	.40/(10.1)
RECEPTACLE	.718/(18.24)	.600/(15.24)	.40/(10.1)	.41/(10.3)

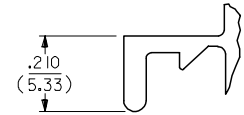

DETAIL 3

.093/(2.36) STANDARD MOUNTING EAR
(SCALE 4:1)

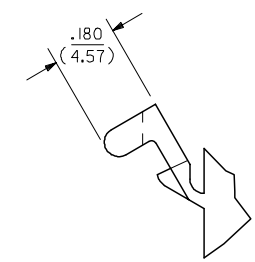
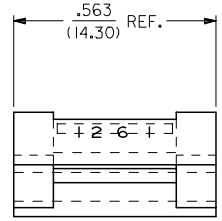

DETAIL 4

.093/(2.36) PREBENT MOUNTING EAR
(SCALE 4:1)

NOTES:

1. MATERIAL: SEE LEGEND
2. FINISH: NONE.
3. PRODUCT SPECIFICATION: PS-43660-9999
4. PACKAGING INFORMATION: PK-1261-001
5. HOUSINGS FOR USE WITH MOLEX .093/(2.36) PIN AND SOCKET TERMINALS.
6. CIRCUIT I.D. NUMBERS ON SIDE OF HOUSING APPEAR ON PARTS FROM TOOLS BUILT AFTER 9/3/91.
7. WHERE DENOTED IN CHART, TOOLS ARE BUILT WITH PREBENT MOUNTING EARS PER DETAIL 4 AND SUPERSEDE ALL TOOLS PREVIOUSLY BUILT WITH THE STANDARD MOUNTING EAR.
8. TEXT AND CIRCUIT IDENTIFIERS ARE SHOWN IN APPROXIMATE LOCATION BUT MAY VARY TO ACCOMMODATE TOOLING.

UPDATED NOTES EC NO: UCP2006-2424 DRAWN: P. DDER 2006/06/08 CHKD: AELHAG 2006/06/08 APPR: FSM TH 2006/06/09 X3	QUALITY SYMBOLS 	GENERAL TOLERANCES (UNLESS SPECIFIED) mm INCH		DIMENSION STYLE IN/MM		SCALE 4:1	DESIGN UNITS INCH	THIRD ANGLE PROJECTION		
		4 PLACES ± .007 ± .007 3 PLACES ± .007 ± .007 2 PLACES ± 0.18 ± .010 1 PLACE ± 0.25 ± .010	DRAWN BY GWF	DATE 11/10/89	CHECKED BY RW	DATE 11/10/89	APPROVED BY GWF	DATE 11/10/89	.093/(2.36) HOUSING, PLUG AND RECEPTACLE, 6 CKT., .198/(5.03) CTRS.	
		DRAFT WHERE APPLICABLE MUST REMAIN WITHIN DIMENSIONS	SEE CHART		MATERIAL NO. SD-1261-*		DOCUMENT NO.		SHEET NO. 2 OF 2	

THIS DRAWING CONTAINS INFORMATION THAT IS PROPRIETARY TO MOLEX INCORPORATED AND SHOULD NOT BE USED WITHOUT WRITTEN PERMISSION